

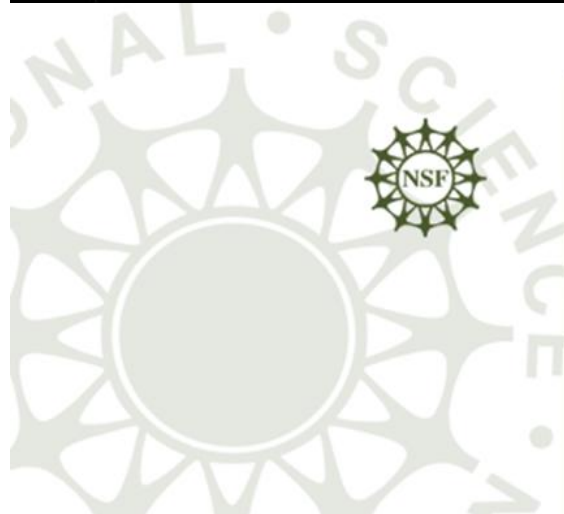

Engineering Advisory Committee Meeting

National Science Foundation
October 24-25, 2007



**National Science Foundation
Directorate for Engineering**

**Richard O. Buckius
Assistant Director**

Engineering Advisory Committee

Agenda

- **National Trends**
 - ◆ America COMPETES
 - ◆ ACI
- **NSF and Engineering Trends**
 - ◆ Proposal and award trends
 - ◆ ENG programs update
 - ◆ Solicitations
- **Broadening Participation**
- **Research Topics**
- **Advisory Committee Discussion Topics**



Engineering Advisory Committee

Role of Advisory Committees

- Provide advice, recommendations, and oversight of Directorate activities.
- Assist in assessing the impact on the Directorate's community of NSF-funded efforts.
- Advise Directorate on program management, overall program balance, and other aspects of program performance.
- Facilitate partnerships.





National Trends



America COMPETES

- America **C**reating **O**pportunities to **M**eaningfully **P**romote **E**xcellence in **T**echnology, **E**ducation and **S**cience Act was passed in August 2007 by Congress and signed by President Bush.
- The Act states: “support and promote innovation research in the United States through high-risk, high-reward projects that meet fundamental scientific and technological challenges, involve multidisciplinary work, and involve a high degree of novelty.”
- Outlines specific allocations for initiatives at NASA, NIST, NOAA, DOE, and NSF, with an emphasis on education.



Education plays a significant role in America COMPETES. Pictured are two students at the University of Texas-EI Paso. *Zubia, 0521650.*



America COMPETES

- Authorizes funding that would increase the NSF budget by 20 percent between FY 2007 and FY 2009.
 - ◆ Authorizes \$115M for Major Research Instrumentation program in FY 2008 and \$123.1M for FY 2009.
 - ◆ Calls on NSF to give priority in selecting awards that meet “critical national needs” in innovation, competitiveness, safety and security, physical and natural sciences, technology, engineering, social science and mathematics.



American Competitiveness Initiative

- The centerpiece of *American Competitiveness Initiative (ACI)* is to double the federal investment in key agencies that support basic research in physical sciences and engineering.
- Over the next 10 years, the Federal agencies impacted are NSF, DOE Science, and NIST.
- ACI includes three broad components:
 - ◆ Research in physical sciences and engineering (including 12 specific goals with 7 related to NSF).
 - ◆ Research and Development tax incentives.
 - ◆ Education and workforce.



American Competitiveness Initiative

FY 2007–FY 2016

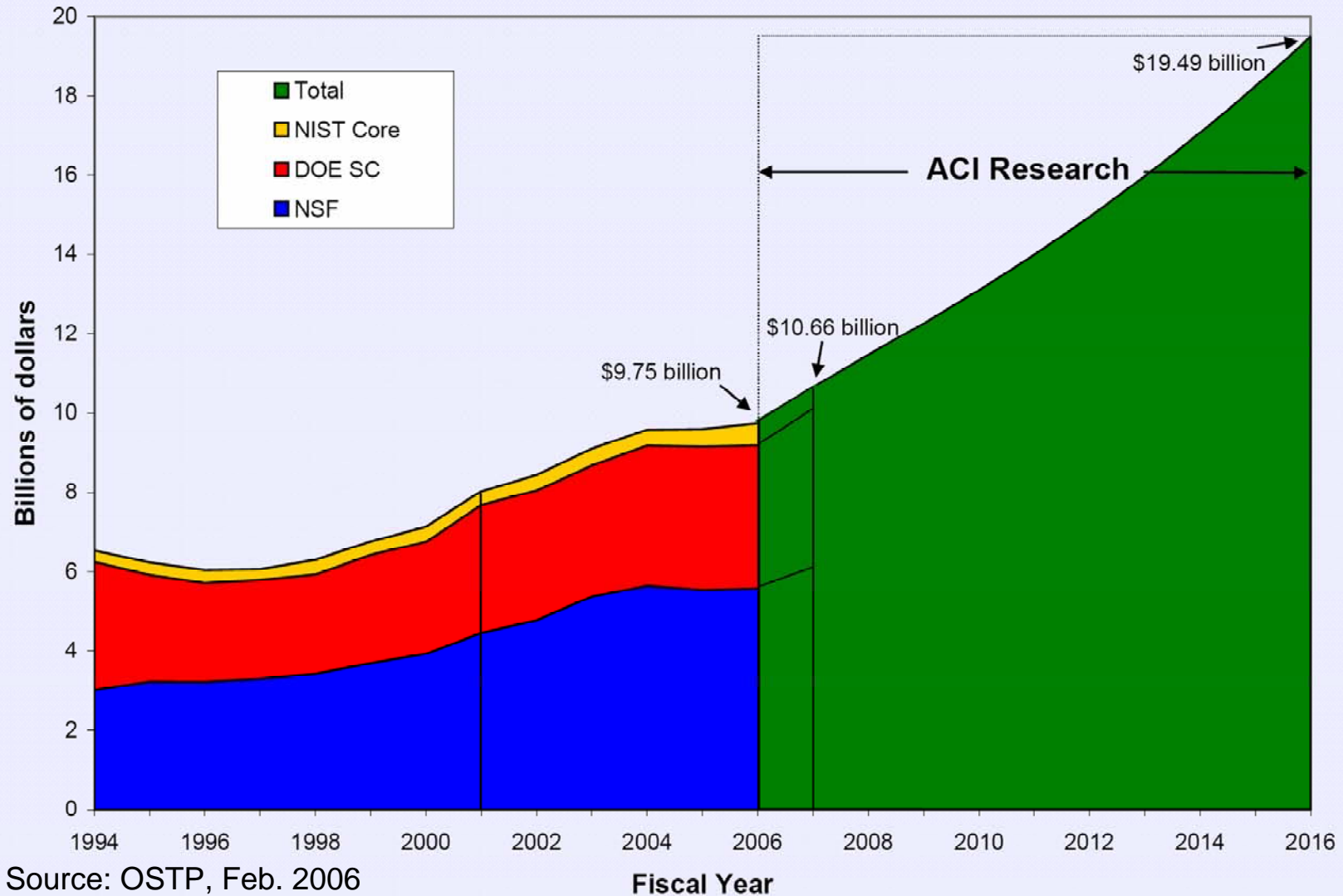

Source: OSTP, Feb. 2006



ACI-Driven NSF Budget Projections

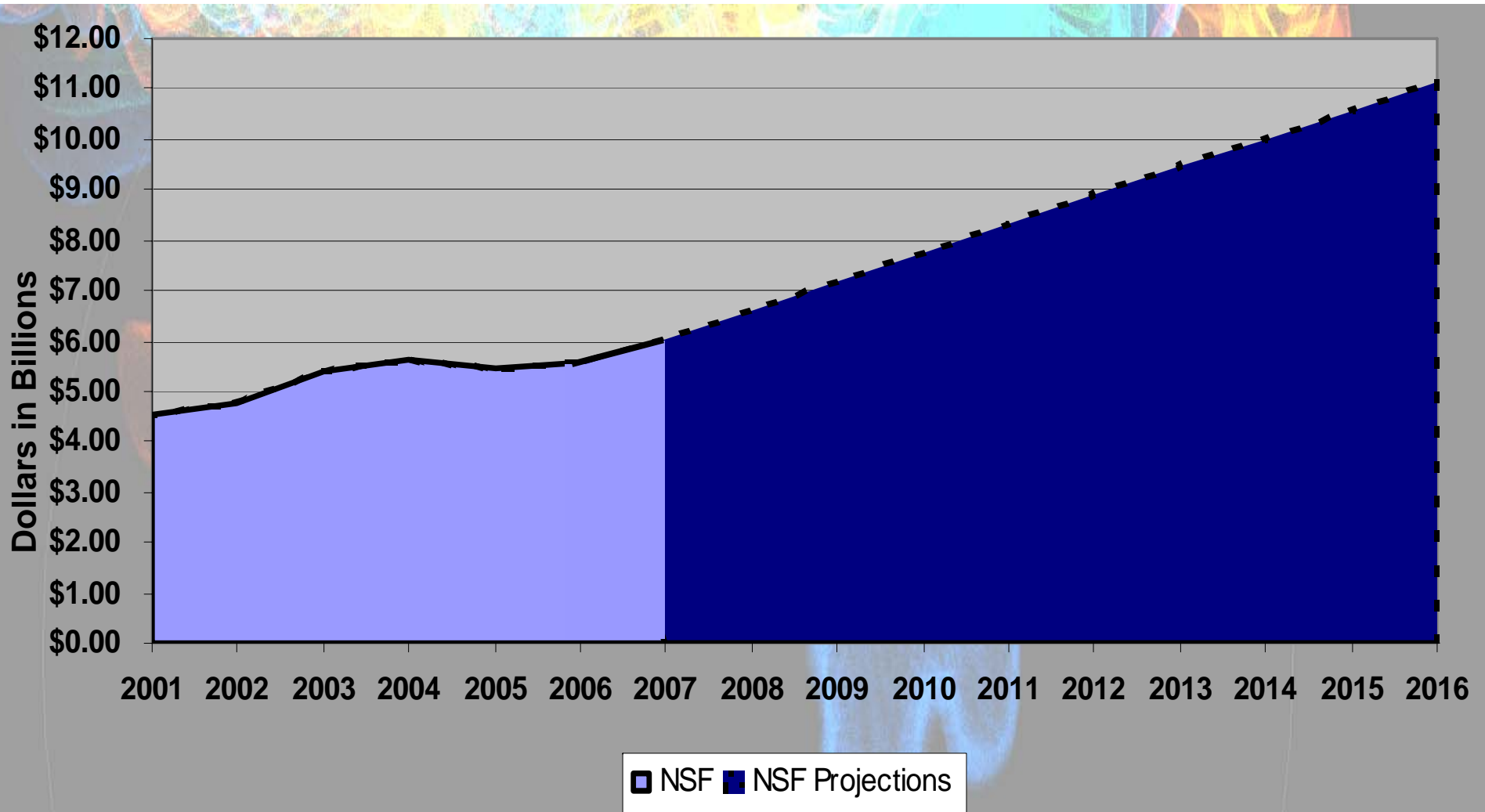

FY 2006 through FY 2016 budgets are estimates based on White House data.





NSF and ENG Trends



NSF Budget by Research Directorate

Dollars in Millions

Directorate	FY 2006 Actual	FY 2007 Plan	FY 2008 Request	FY 2008 Request			
				Change over FY 2006 Actual		Change over FY 2007 Request	
				Amt	%	Amt	%
BIO	\$580.90	\$607.85	\$633.00	\$52.10	9.0%	\$25.15	4.1%
CISE	\$496.35	526.69	574.00	77.65	15.6%	47.31	9.0%
ENG (<i>less SBIR/STTR</i>)	\$486.01	519.67	566.89	80.50	16.6%	47.22	9.1%
SBIR/STTR	\$99.45	108.88	116.41	17.34	17.5%	7.53	6.9%
GEO	\$703.95	744.85	792.00	88.05	12.5%	47.15	6.3%
MPS	\$1,086.61	1,150.30	1,253.00	166.39	15.3%	102.70	8.9%
SBE	\$201.23	213.76	222.00	20.78	10.3%	8.24	3.9%
OCI	\$127.14	182.42	200.00	72.86	57.3%	17.58	9.6%
OISE	\$42.61	40.61	45.00	2.39	5.6%	4.39	10.8%
OPP	\$390.54	438.10	464.90	74.37	19.0%	26.80	6.1%
IA	\$233.30	231.37	263.00	29.70	12.7%	31.63	13.7%
U.S. Arctic Research Commission	\$1.17	\$1.45	\$1.49	0.32	27.4%	0.04	2.8%
Research & Related Activities	\$4,449.25	\$4,765.95	\$5,131.69	\$682.44	15.3%	\$365.74	7.7%



PI and Co-PI Submissions

ENG Research Grants

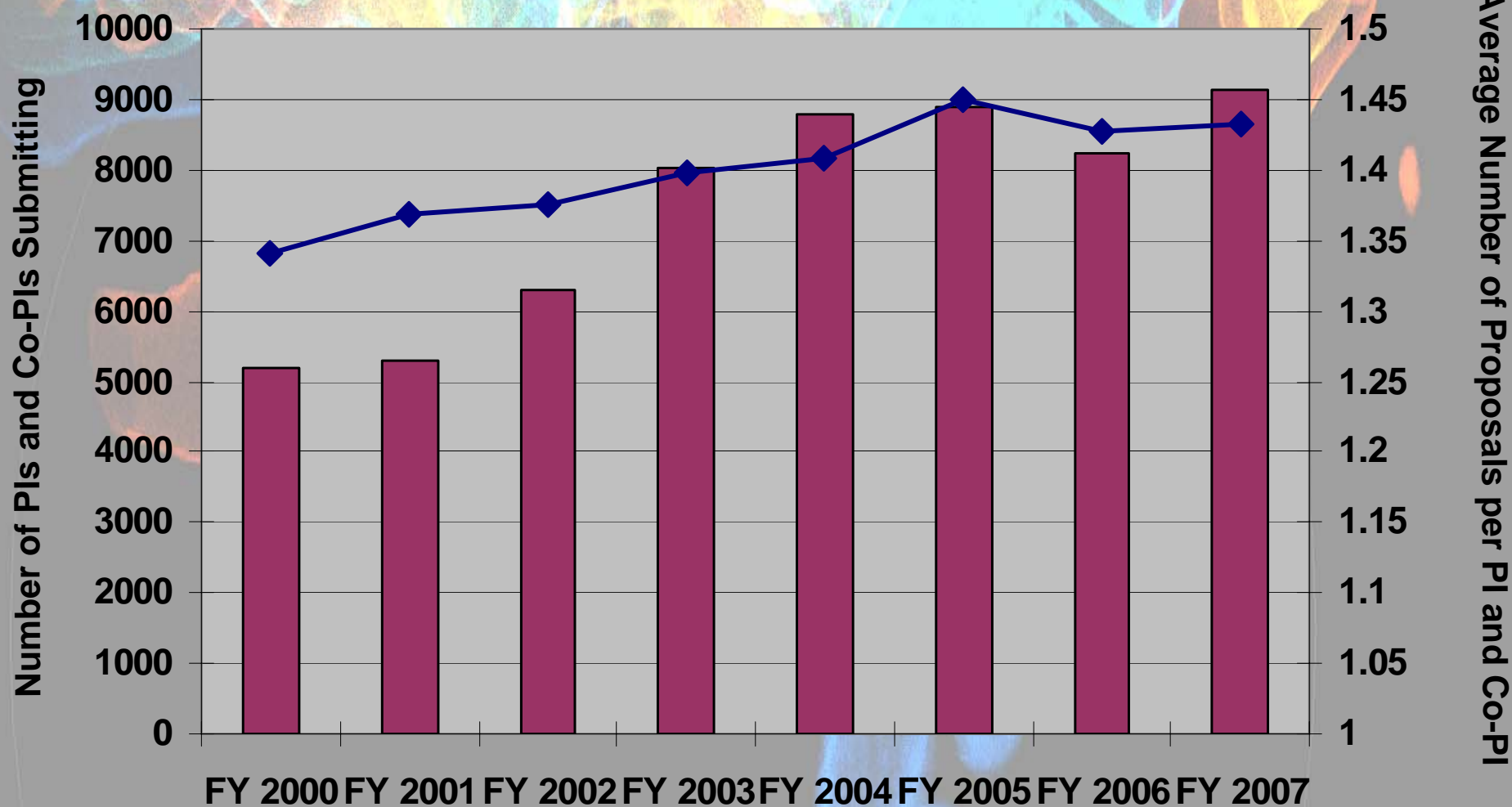

Number of PIs and Co-PIs Submitting — Average Number of Proposals per PI and Co-PI



ENG and NSF Funding Rates

Research Grants

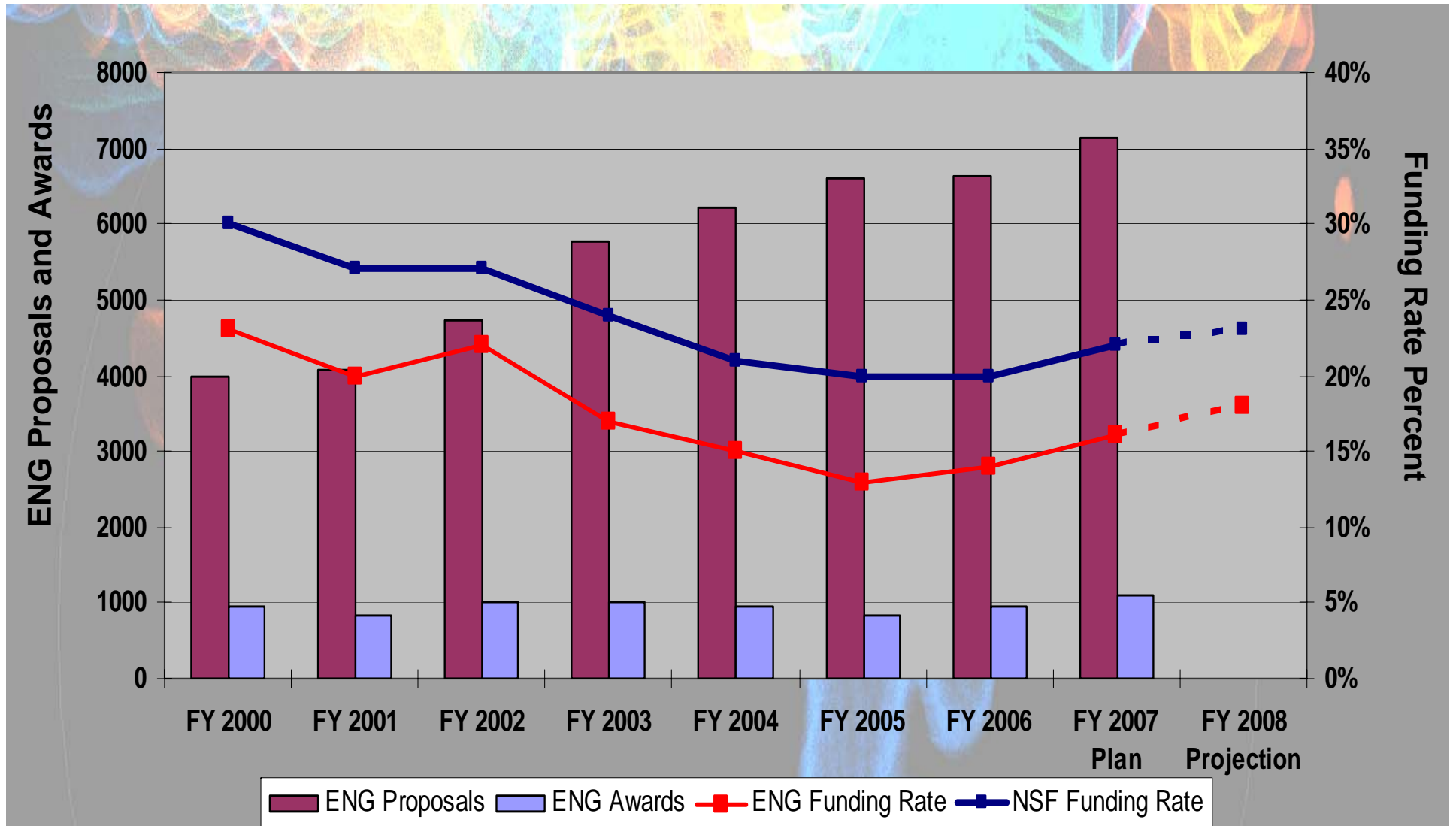

Annual Award Size

Averages for ENG Research Grants

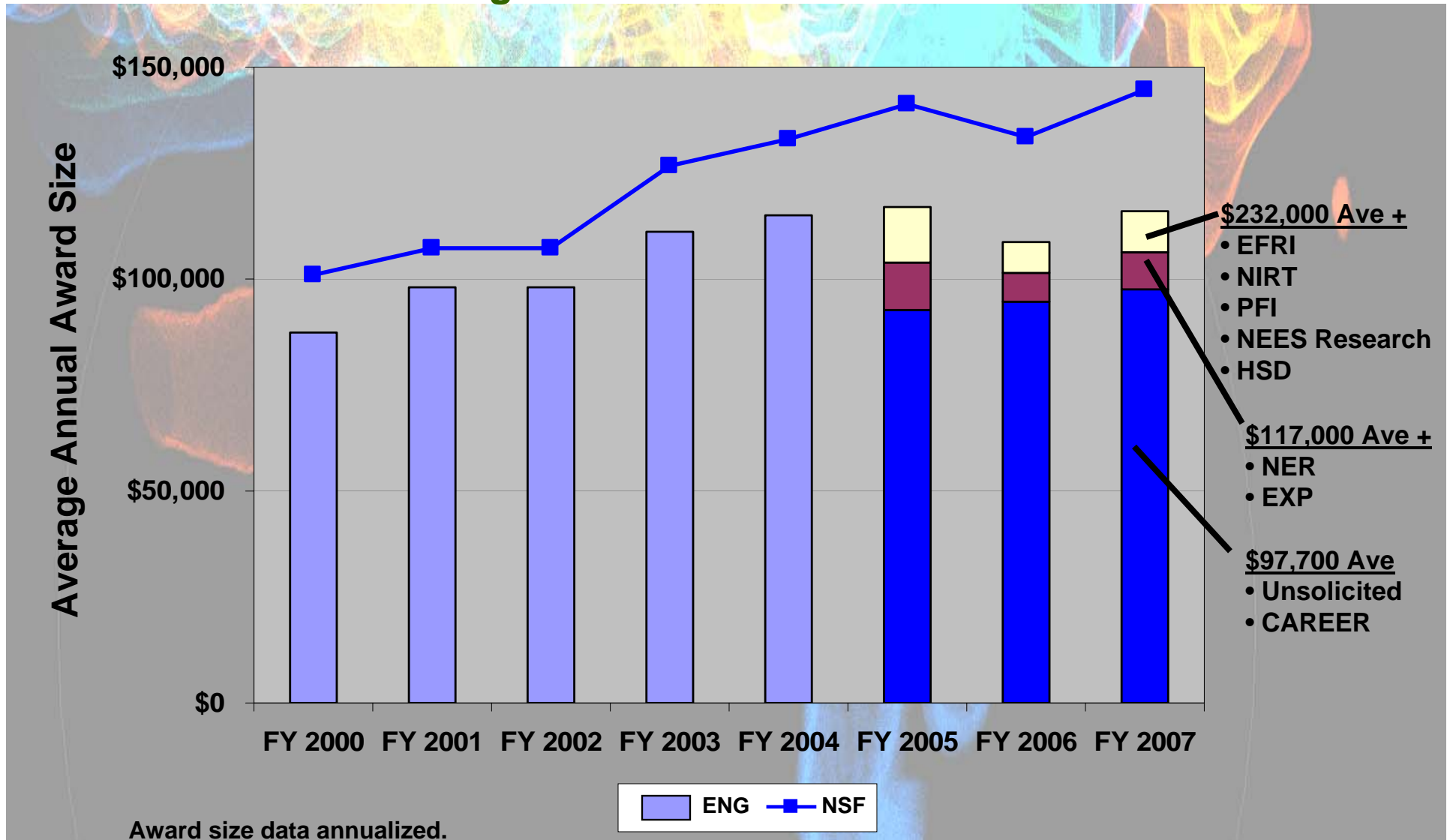

Average Award Duration in Years

ENG Research Grants in Comparison to NSF

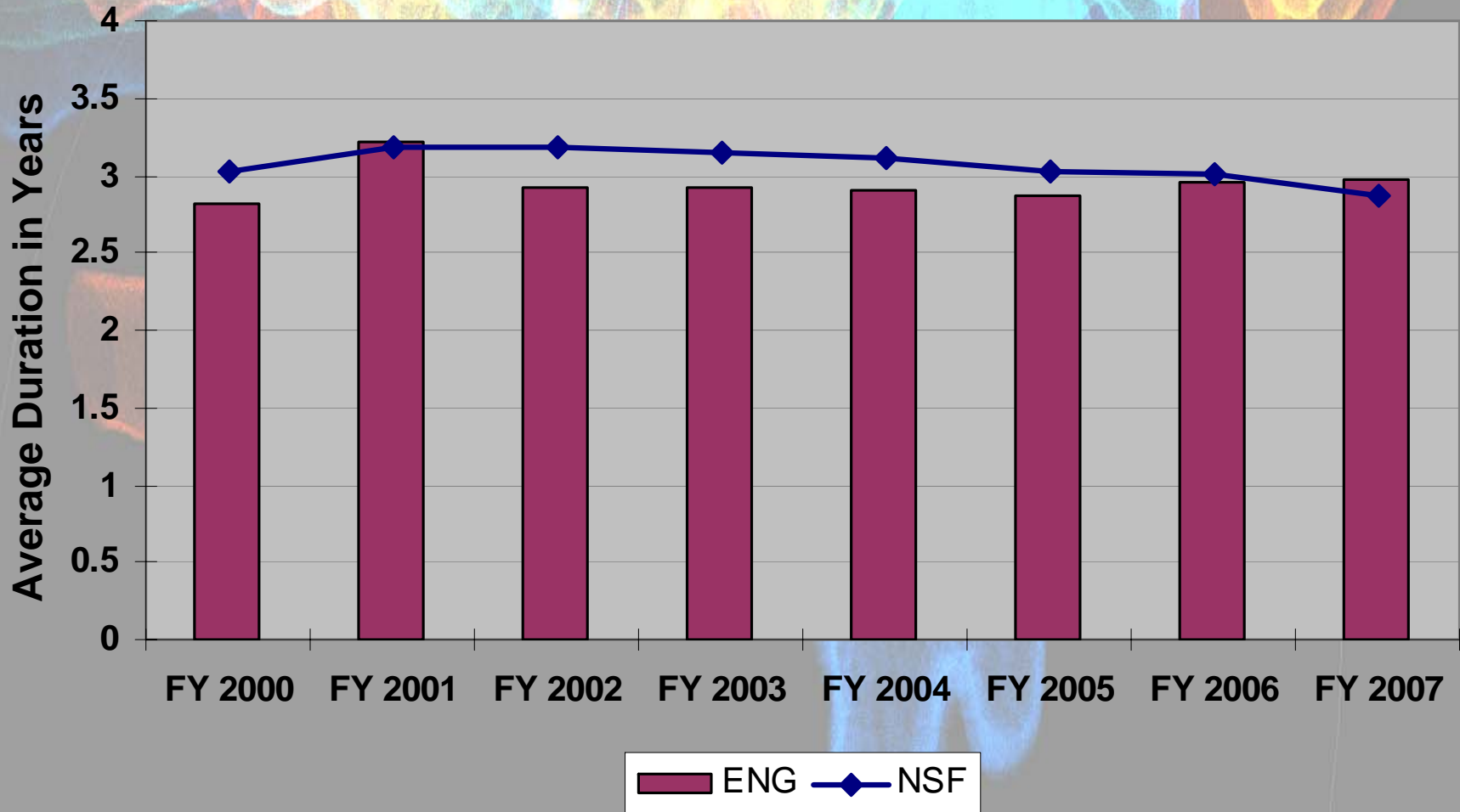

ENG Funding Analysis

Fenced vs. Constrained vs. Unfenced

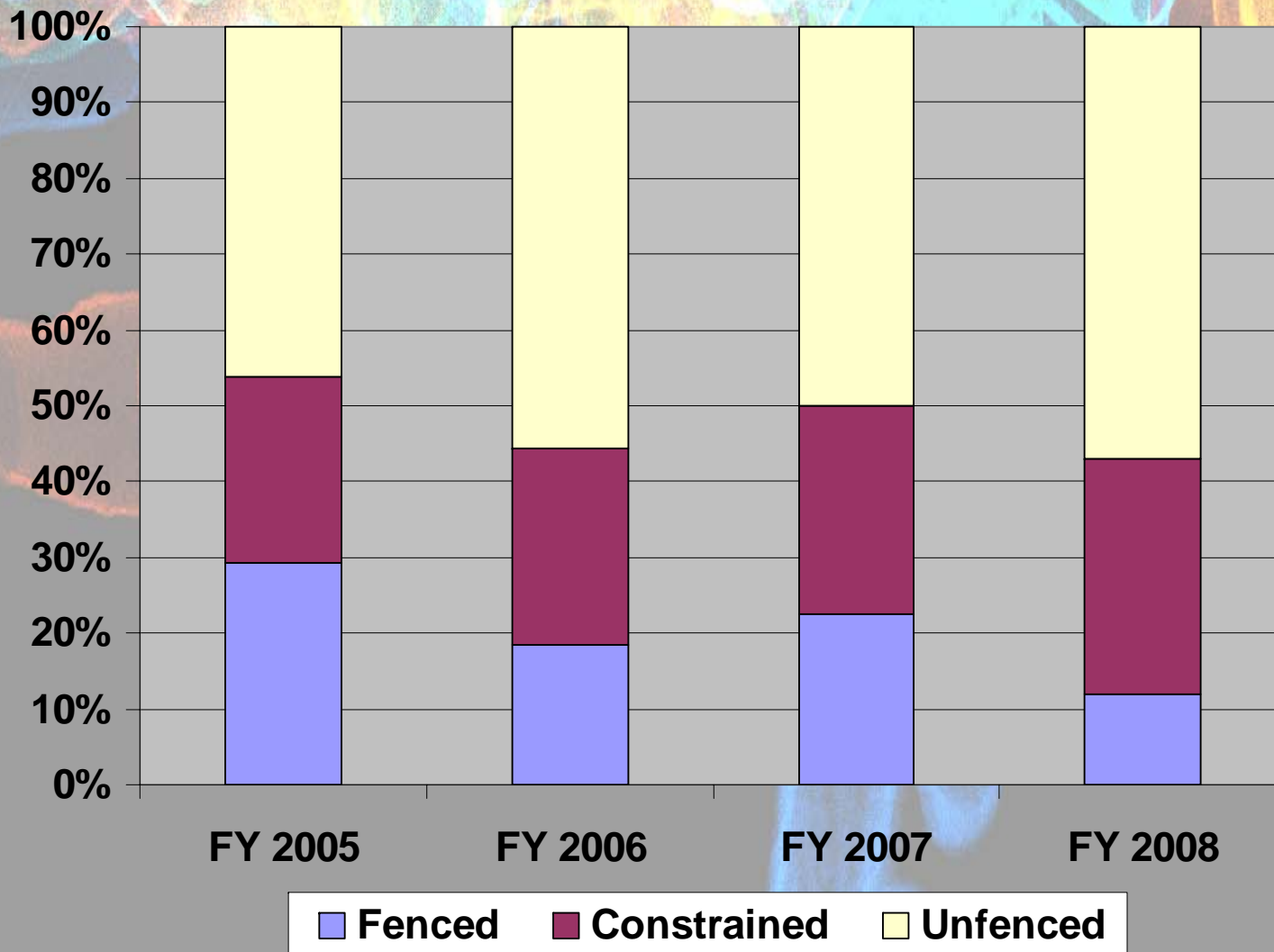

ENG Research Collaborations

Percent of Single PI vs. Multiple Investigator Awards

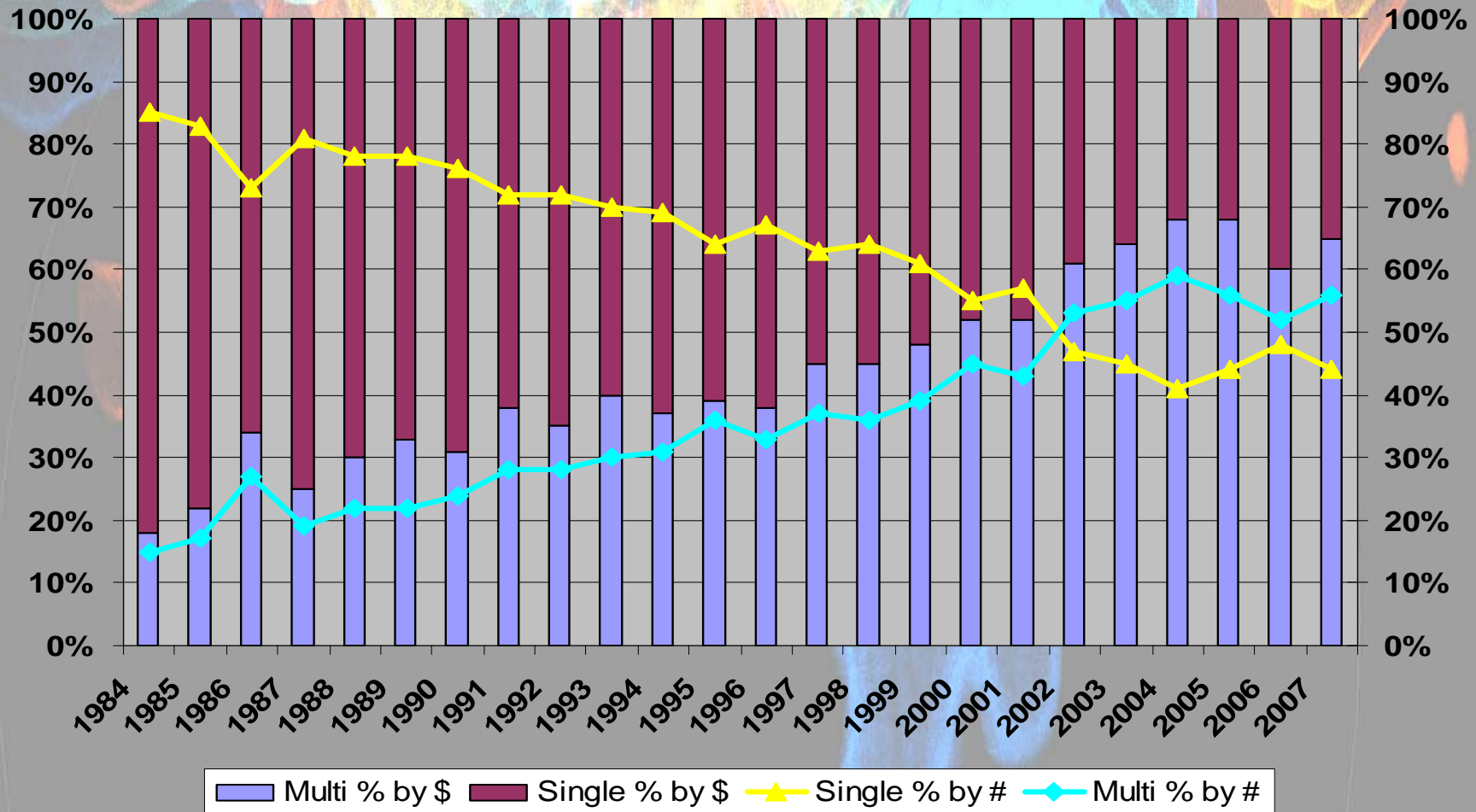

Cybersystems

ECCS

Cybersystems
Scott Midkiff

- Supports fundamental research that integrates physical devices with distributed sensing and actuation, communications, storage, computation and control of complex systems that enables visualization, analysis and reconfiguration for reliable and agile infrastructures for domain-specific applications.
- Two submission windows each year—October 7, 2007 and February 7, 2008.
- 63 proposals reviewed in FY 2007.
- Areas supported include: Hybrid and integrative networks, integrated signal processing for high-performance computing and networking, and new algorithms and architectures for secure and robust computing.



Environmental Sustainability

CBET

Environmental
Sustainability
Bruce Hamilton

- Supports engineering research with the goal of promoting sustainable engineered systems that support human well-being and that also are compatible with sustaining natural (environmental) systems, which provide ecological services vital for human survival.
- Two submission windows each year—September 15, 2007 and March 1, 2008.
- 48 proposals received in one window in FY 2007.
- Areas supported include:
 - ◆ Green Engineering
 - ◆ Ecological Engineering
 - ◆ Industrial Ecology
 - ◆ Earth Systems Engineering
 - ◆ Other



Energy for Sustainability

CBET

Energy for
Sustainability
Trung Van Nguyen

- Supports fundamental research and education in the areas of
 - ◆ Energy production, conversion, and storage, and
 - ◆ Energy sources that are environmentally friendly and renewable.
- Two submission windows each year—September 15, 2007 and March 1, 2008.
- 190 proposals reviewed from one window in FY 2007.
- Areas supported include:
 - ◆ Fuel Cells
 - ◆ Hydrogen storage
 - ◆ Bio-related
 - ◆ Others – solar-related, renewable energy sources, wind-related



Cyber-Enabled Discovery & Innovation (CDI)

- Employ advances in computational **concepts, methods, models, algorithms, and tools** (computational thinking) for revolutionary science and for generating and applying new knowledge.
- CDI seeks ambitious, transformative, multidisciplinary research proposals within or across the following three thematic areas:
 - From **Data to Knowledge**: enhancing human cognition and generating new knowledge from a wealth of heterogeneous digital data.
 - **Understanding Complexity** in Natural, Built, and Social Systems: deriving fundamental insights on systems comprising multiple interacting elements.
 - Building **Virtual Organizations**: enhancing discovery and innovation by bringing people and resources together across institutional, geographical and cultural boundaries.



Cyber-Enabled Discovery & Innovation (CDI)

- A competitive CDI proposal will:
 - Describe an ambitious research and/or education agenda that, through computational thinking, promises **paradigm-shifting advances in more than one field** of science or engineering;
 - Provide a **compelling rationale** for how innovations in, and/or innovative use of, computational thinking will yield the desired project outcomes; and
 - Draw on **productive intellectual partnerships** that capitalize upon synergies of knowledge and expertise. These partnerships will cross multiple fields or sub-fields of science or engineering, and/or multiple types of organizations, including academic, for-profit, and not-for-profit entities, both foreign and domestic.
- Please note, CDI review criteria are fully compliant with the updated NSF review criteria, which can be found on: <http://www.nsf.gov/pubs/2007/in130/in130.jsp>



National Nanotechnology Initiative

Funding Opportunities at NSF in FY 2008

www.nsf.gov/nano

- NSF supports nanoscale science and engineering in FY 2008 through:
- ◆ Competitive awards in existing (core) programs, including interdisciplinary team research proposals.
 - ◆ Competitive awards via the FY 2008 "Center for the Environmental Implications of Nanotechnology (CEIN)" solicitation (NSF 07-590).
 - ◆ FY 2008 EPA-NSF-DOE research solicitation: "Nanotechnology Research Grants Investigating Fate, Transport, Transformation, and Exposure of Engineered Nanomaterials."
 - ◆ FY 2008 "NSF-SIA/NRI Graduate Student and Postdoctoral Fellow Supplements to NSF Centers in Nanoelectronics" (NSF 07-051).



Recent Solicitations

- **ADVANCE: Increasing the Participation of Women in Academic Science and Engineering Careers**—NSF 07-582, Jan. 7, 2008
- **ARI: Joint Domestic Nuclear Detection Office/National Science Foundation: Academic Research Initiative**—NSF 07-545, first Wednesday in April, annually through 2011.
- **BRIGE: Broadening Participation Research Initiation Grants in Engineering**—NSF 07-589, Feb. 8, 2008.
- **CEIN: Center for the Environmental Implications of Nanotechnology**—NSF 07-590, Prelim. Proposals; March 17, 2008.
- **CDI: Cyber-Enabled Discovery and Innovation**—NSF 07-603, Letter of Intent Oct. 30, 2007–Nov. 30, 2007.
- **GOALI: Grant Opportunities for Academic Liaison with Industry**—NSF 07-522.
- **RET and REU (Research Experiences for Teachers, Undergraduates)**—NSF 07-557, NSF 07-569, Nov. 19, 2007; August 18, 2008.





ENG Broadening Participation Activities



ENG Broadening Participation

ENG Diversity Working Group and Goals

- **Engineering Diversity Working Group (EDWG)**
 - ◆ Representatives from all ENG divisions.
 - ◆ Developing a draft plan for broadening participation in ENG.
 - ◆ These recommended initiatives and programs focus on all members of the engineering academic community, from K–20 to faculty.
- **Engineering Diversity Goals**
 - ◆ Realize excellence through diversity.
 - ◆ Enable the integration and success of a diverse engineering workforce, both inside and outside NSF.
 - ◆ Make the demographics of engineering disciplines representative of the US census.



ENG Broadening Participation

Draft Recommendations – K through Postdoc

→ K-12:

- ◆ Expand the **Research Experiences for Teachers (RET)** program significantly and maintain overall success in broadening participation.

→ Undergraduate:

- ◆ Expand the **Research Experiences for Undergraduates (REU)** program to include a broadening participation theme.
- ◆ Initiate specific programs to address the needs of each underrepresented group.

→ Graduate:

- ◆ Develop a broadening participation graduate award that is portable—similar to the **Graduate Research Fellowship Program**—and encompasses all ENG divisions.

→ Post-doctoral research:

- ◆ Develop a portable research initiation grant to broaden participation of post-docs in ENG.



ENG Broadening Participation

BRIGE

- **Broadening Participation Research Initiation Grants in Engineering (BRIGE)**
 - ◆ **Research initiation grant funding opportunity intended to increase the diversity of researchers through research program support early in their careers, including under-represented groups, engineers at minority serving institutions, and persons with disabilities.**
 - ◆ **Up to \$175,000 over two years.**
 - ◆ **Early career faculty (fewer than three years).**
 - ◆ **Announced in September 2007 with a submission date of February 8, 2008.**
 - ◆ **NSF 07-58 at**
<http://www.nsf.gov/pubs/2007/nsf07589/nsf07589.htm>



ENG Broadening Participation

Draft Recommendations – Faculty

- Implement the **BRIGE (Broadening Participation Research Initiation Grants in Engineering)** program.
 - ◆ Expand the **BRIGE** to provide funding for a faculty mentor.
 - ◆ Initiate a **career advancement award** to broaden participation of senior faculty and complement the **BRIGE** program.
- Hold **broadening participation workshops** for department chairs from each of the major **ENG** disciplines, e.g., chemical, mechanical, electrical, computer, civil, industrial, materials, ...
- To promote technical collaboration with international scholars, hold periodic **international workshops** for U.S. women **ENG** faculty and grad students.
- Promote collaboration between non-minority- and minority-serving institutions through expanded research-oriented **workshops at minority-serving institutions.**



ENG Broadening Participation

Current ENG Activities

→ Funding rates for research proposals among all ENG, women, and minorities

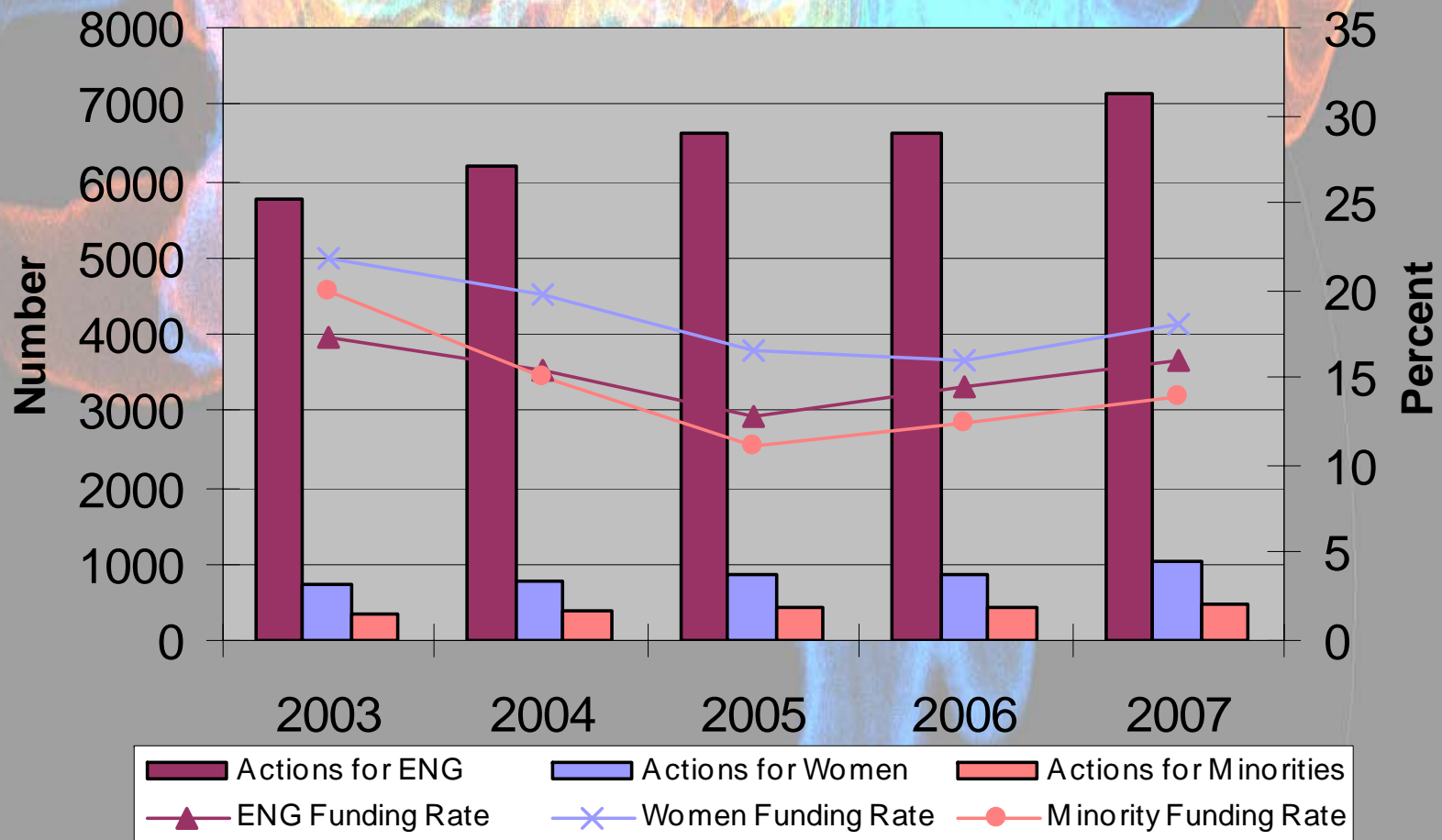

ENG Broadening Participation

Current ENG Activities

→ CAREER funding rates for women and all ENG

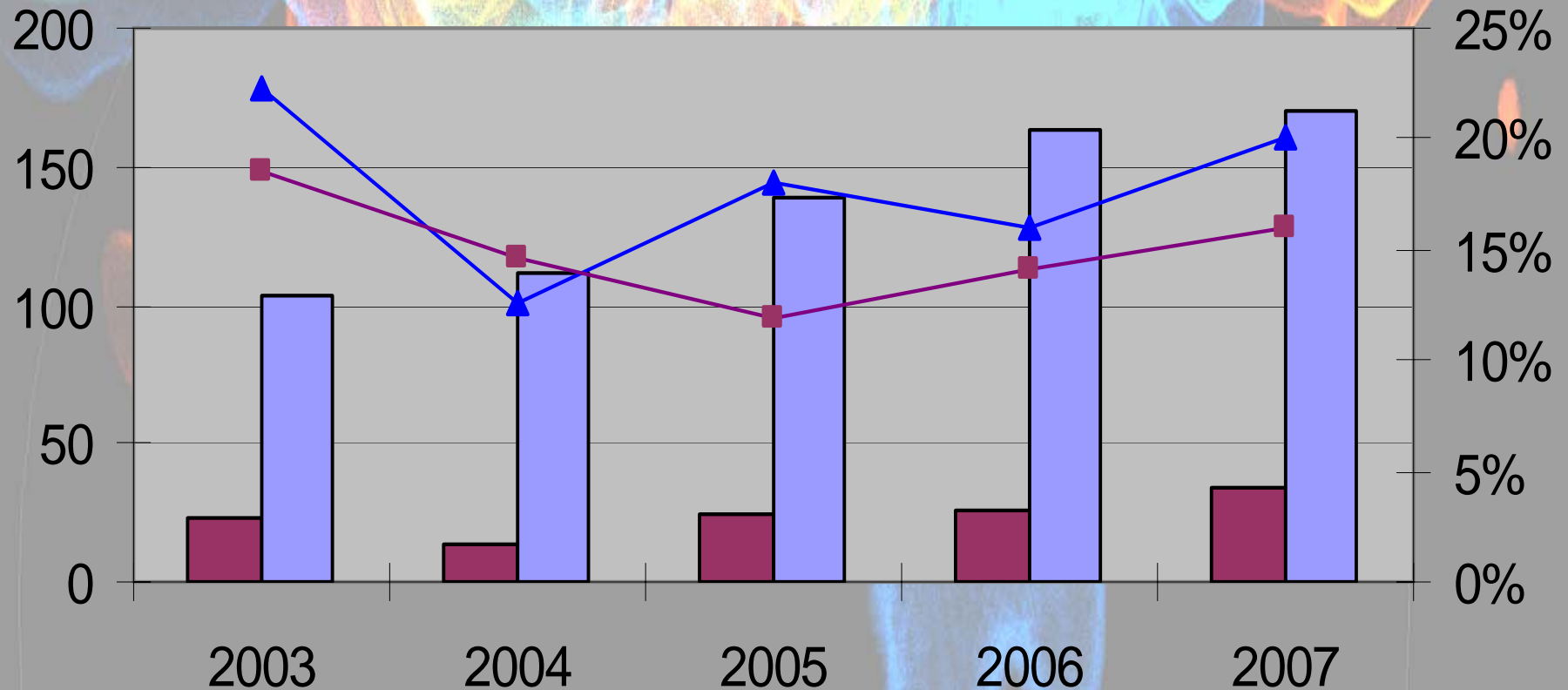

■ Awards - Women ■ Actions - Women ▲ % Women ■ % ENG



ENG Broadening Participation

Current ENG Activities

→ CAREER funding rates for minorities and all ENG

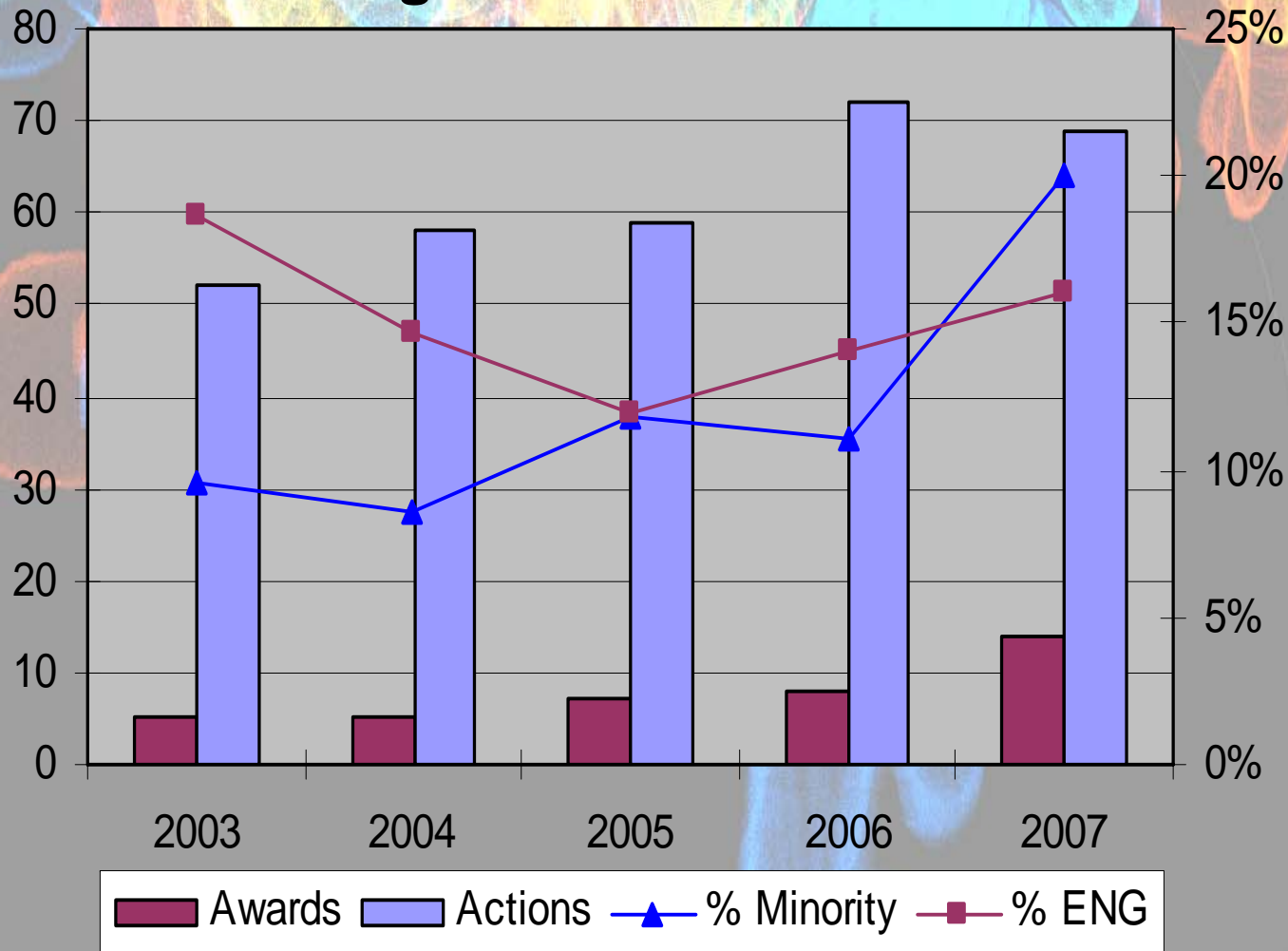

ENG Broadening Participation

ENG Proposals from Women and Undeclared Gender

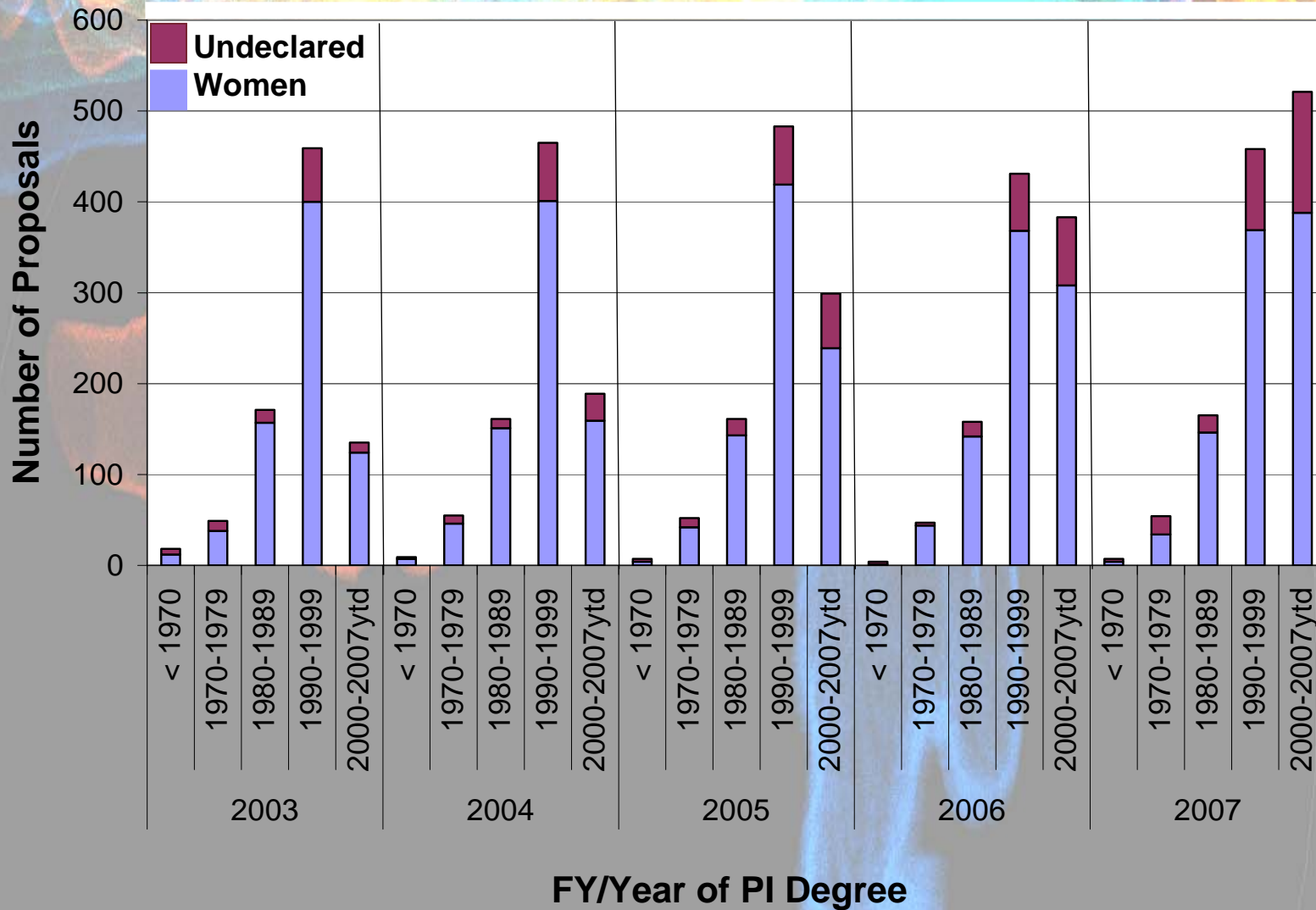

ENG Broadening Participation

ENG Proposals from Minorities and Undeclared Ethnicity

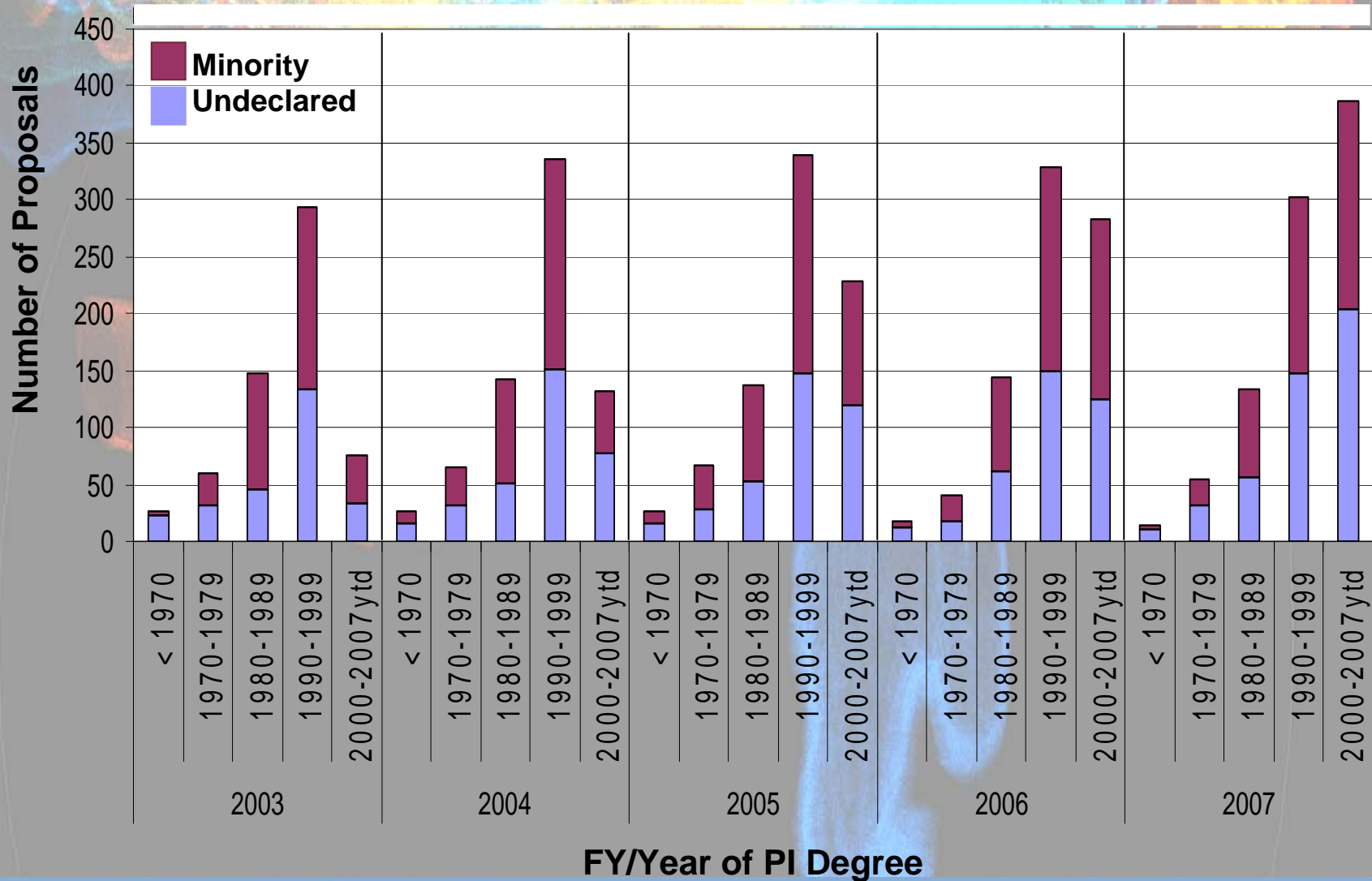

ENG Broadening Participation

Current ENG Activities

- **Research Experiences for Teachers (RET)**
 - ◆ Includes both sites and supplements.
 - ◆ Two supplements per grant allowed if one teacher is disabled, or a minority or a woman.

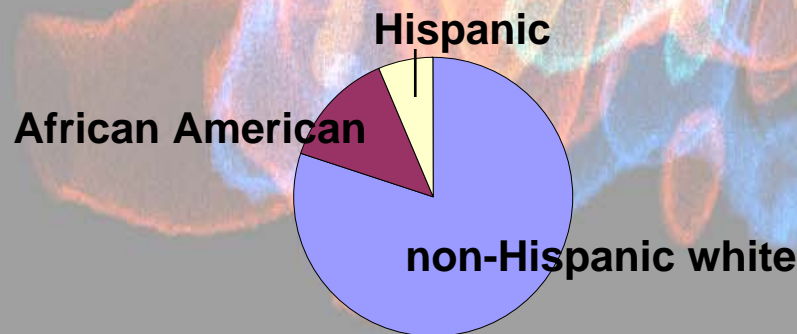

RET teachers 2001–2003

2% Asian
<1% American Indian
46% women
54% men

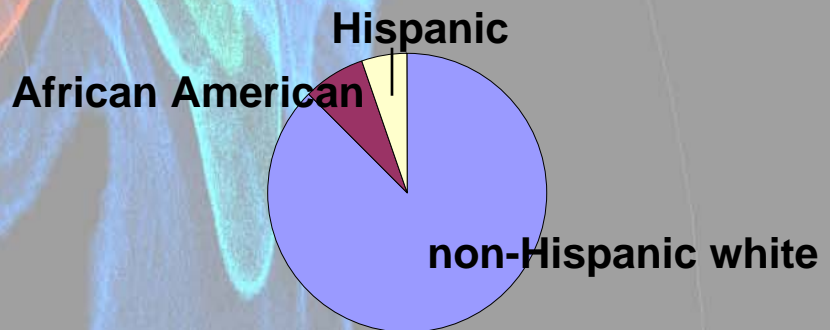

National Average

Source: *Evaluation of the Research Experiences for Teachers Program Final Report*, SRI International, NSF Contract Number EEC-9815426, Sept. 30, 2005



ENG Broadening Participation

Current ENG Activities

- **Research Experiences for Undergraduates (REU)** supplements to research awards include underrepresented groups.
- **Tribal College activities**
 - ◆ Initial award at Oglala Lakota College, South Dakota.
 - ◆ Several ENG awardees include local tribal colleges and reservations in outreach.
- **Graduate Research Supplements (GRS)**
 - ◆ Supported by all ENG divisions.
 - ◆ Provides stipend for an additional Ph.D. student to broaden participation.



ENG Broadening Participation

Current ENG Activities

- **Engineering Research Centers (ERCs)**
 - ◆ Each ERC is required to craft a diversity plan that includes underrepresented groups.
 - ◆ Each ERC is required to collaborate with at least one of the minority-focused programs in the Directorate for Education and Human Resources.
 - ◆ Each ERC is required to engage in K–12 outreach.



ENG Broadening Participation

Current ENG Activities

- Broadening Participation Research Initiation Grants in Engineering (BRIGE).
- Research-oriented workshops at minority-serving institutions to promote collaboration with other institutions.
- Numerous divisional workshops and sessions at grantees meetings to explain and promote broadening participation.
- Proposal-writing workshops for faculty from underrepresented groups.
- Quality Education for Minorities (QEM) CAREER Faculty Workshop.





Research Topics



Directorate for Engineering

Research and Education Topics

Engineering research spans the frontiers

- To more effectively support fundamental research and education, ENG identifies research and education topics.
- The topics represent a convergence of fields, disciplines, and frontier opportunities that crosscut divisions, and give general guidance on the potential future directions of engineering research.
- Topic designations will evolve over time, reflecting the maturation of certain fields, the emergence of new fields, and the shift in demand from society for significant progress on grand challenges.

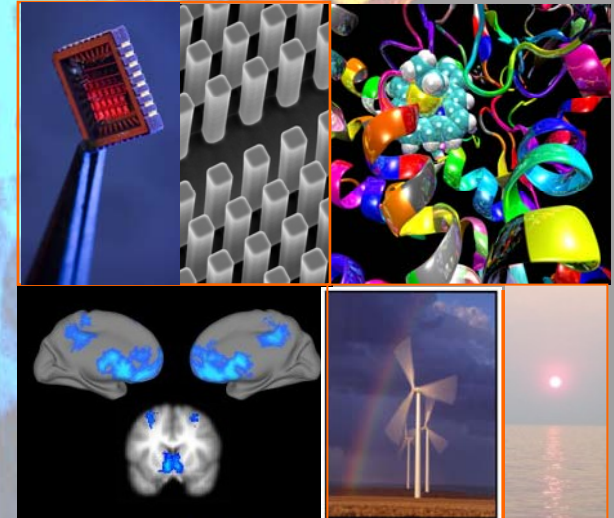

Engineering contributes at all scales. Examples are nanotechnology, computational simulation, health, and alternative energy.



Directorate for Engineering

Research and Education Topics

Cognitive Engineering: Intersection of Engineering and Cognitive Sciences

- Supports engineering methods and systems for improving understanding of brain and nervous system.
- Enables research on how to mimic nervous system processes to engineer better systems, machines and technologies.
- Provides a foundation for competitive innovations—such as intelligent machines that analyze and adapt—called for in ACI.

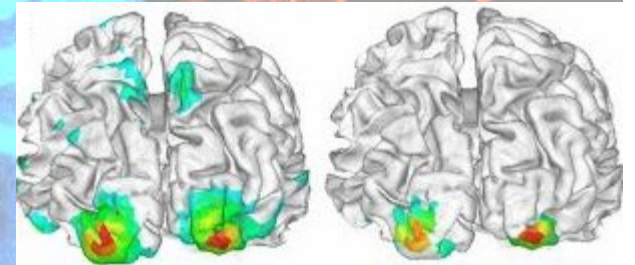

Combining EEG with functional MRI data (left image is EEG, right image shows both) enables precise mapping of brain activity. *He, 0411898.*



Directorate for Engineering

Research and Education Topics

Competitive Manufacturing and Service Enterprises

- Research supports innovation for understanding and thus specifying how materials are made at many scales.
- Development of efficient systems provides foundation for better delivery of services, such as making health care and health information more accessible.
- ACI goal for advances in materials science and engineering; and to create world-class capacity in nanomanufacturing.



Groza, 0523063.

Nanoparticles compose a lightweight biocompatible material for bone implants (left); or they enhance the efficiency of a flexible solar cell (middle). Nanorods can be layered as a coating (bottom) that reflects almost no light and could potentially increase solar cell efficiency.

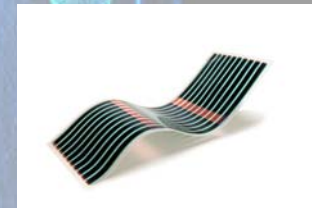

Konarka Technologies Inc., 0450532.

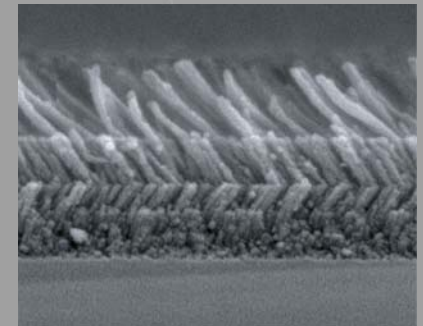

Schubert, 0725615.



Directorate for Engineering

Research and Education Topics

Complexity in Engineered and Natural Systems

- Addresses unifying principles that enable modeling, prediction, and control of emergent behavior in complex systems.
- Impacts specific national research goals, including materials for improving structural performances during natural disasters, overcoming barriers to quantum information processing, and world-leading automation and control technologies.
- This research enhances our ability to understanding of natural systems, engineered systems, and interface of natural and engineered systems.

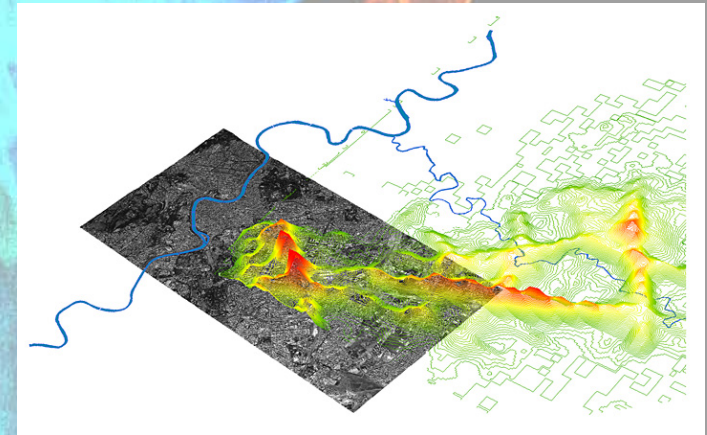

Combining maps (gray square) and density of cell-phone usage (shown as red and yellow 3-D peaks) can yield complex system response unplanned events. *Dahleh, 0735956* .



Directorate for Engineering

Research and Education Topics

Energy, Water and the Environment

- Enables breakthroughs essential to harness, efficiently store, and economically distribute energy from alternative sources.
- Fosters research on materials and methods for assuring a supply of clean water.
- Develops new technologies needed to make energy use more efficient and thus to lessen energy demand.
- Meets the ACI goal of efficient, economic and sustainable use of energy.

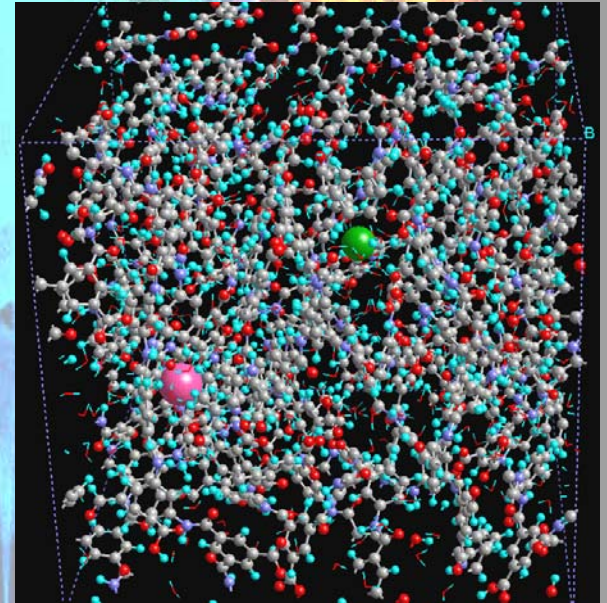

Advanced water purification and desalinization begins with a detailed understanding of how ions in water interact with purification membranes. This dynamic computer simulation shows sodium (pink) and chlorine (green) ions inside a polyamide membrane. *Shannon, 0120978.*



Directorate for Engineering

Research and Education Topics

Systems Nanotechnology

- Next frontier: create controllable systems built from nanoscale components.
- Wide application: new materials, petascale computing, organ regeneration, biological sensors for health monitoring, high-specificity sensors for national security.
- Meets the ACI goal for nanomanufacturing, as well as for developing high-end computing capability; overcoming technological barriers to efficient and economic use of energy; and improvement of sensor detection capabilities.

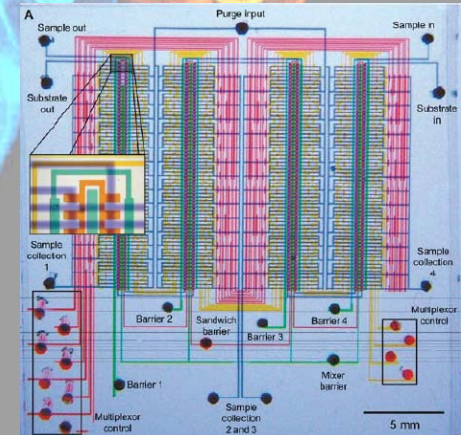

Integrated circuits that are smaller and faster are possible with microfluidics systems built from or incorporating nanocomponents.

Ferreira, 0328162.





Advisory Committee Discussion



Advisory Committee Discussion

Questions

→ EFRI Processes

- ◆ Should EFRI repeat topics for more than years (e.g., two consecutive years)? What are pros and cons?
- ◆ Should EFRI have an "open" category where the topic is not pre-specified? What are pros and cons?
- ◆ Do you have any suggestions on improving this mechanism particularly in terms of receiving more EFRI-inspired input from the broader Engineering community?

→ IPAMM

- ◆ For ENG, what are the appropriate funding rates and award sizes? What is an appropriate balance?
- ◆ What are the appropriate uses of and approaches to limiting proposal submissions? – by PI, Institution, other... range of limitations based upon institution size, type, ..?



Advisory Committee Discussion

Questions

- **Future Engineering Topics**
 - ◆ Recognizing the scope of programs in the Directorate for Engineering, are there other frontier topics and/or focused subtopics of these areas that should be emphasized? Are there topics that should not be considered?
- **University-Industry Partnerships**
 - ◆ Are there other themes that the subcommittee should include?
- **Broadening Participation**
 - ◆ How can we encourage reviewers to provide demographic data?
 - ◆ Please provide feedback on how you think the community could most effectively receive information about broadening participation.



Engineering Advisory Committee

Future Meeting Dates

Spring 2008

April 24-25, 2008

Fall 2008

October 15-16, 2008

Spring 2009

April 22-23, 2009

Fall 2009

October 14-15, 2009





Thank you

